

# MODEL B SEAT ROLLER INSTALLATION



concept2.com

TOOLS NEEDED: Two 7/16" (11mm) wrenches

**NOTE:** Newer ergometers have two extra sets of holes across the top of the metal seat bracket where two additional rollers may be installed. We recommend extra rollers for heavy use situations where seat roller wear may become a problem.

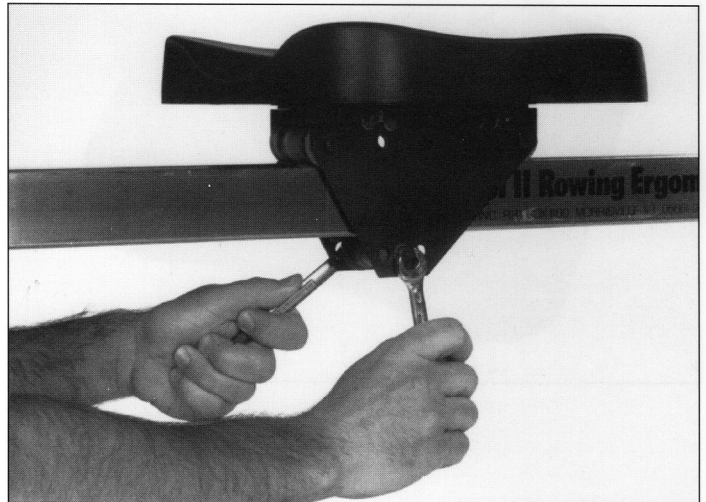

1.

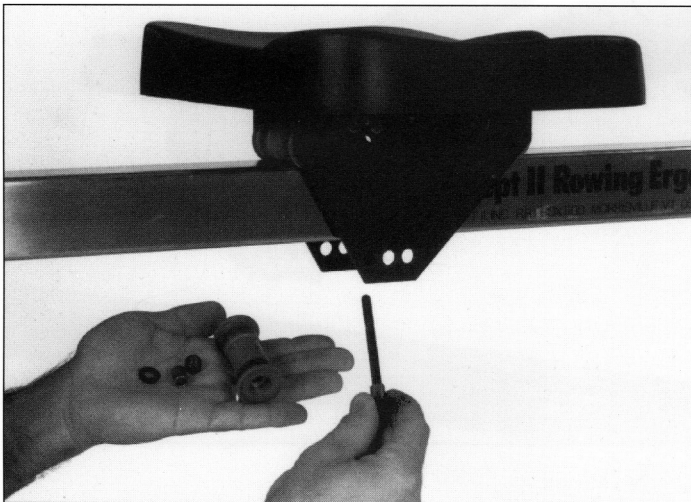

2.



3.

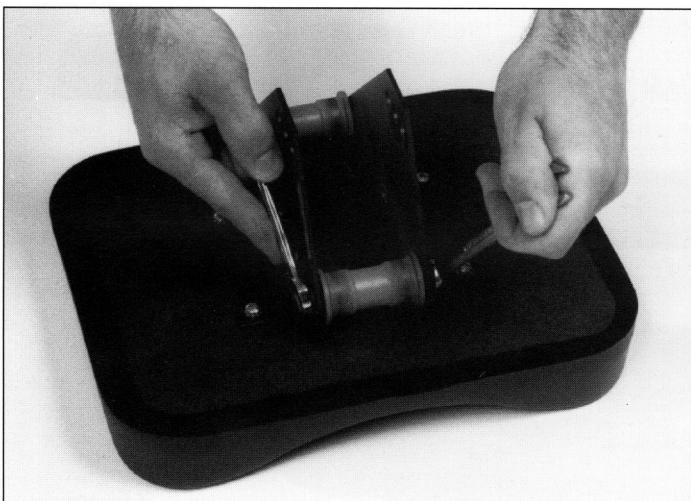

4.



5.





6.

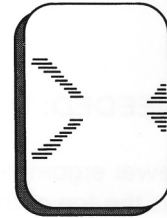
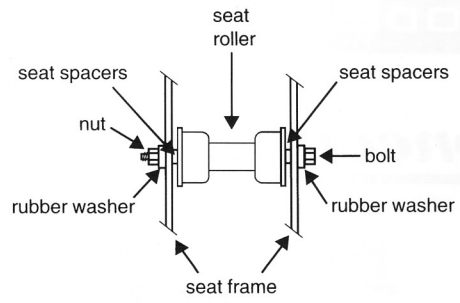

Front of Seat (top view)

7.



8.

Tighten nuts until rubber washers just begin to deform.

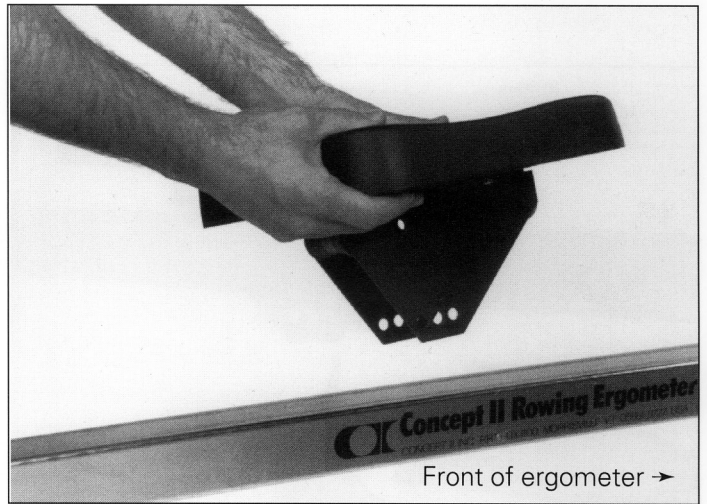

9.

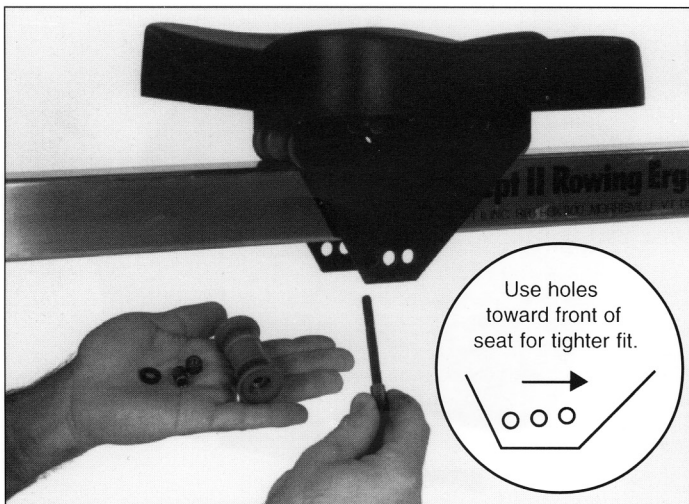

Install in same order as #7.

10.

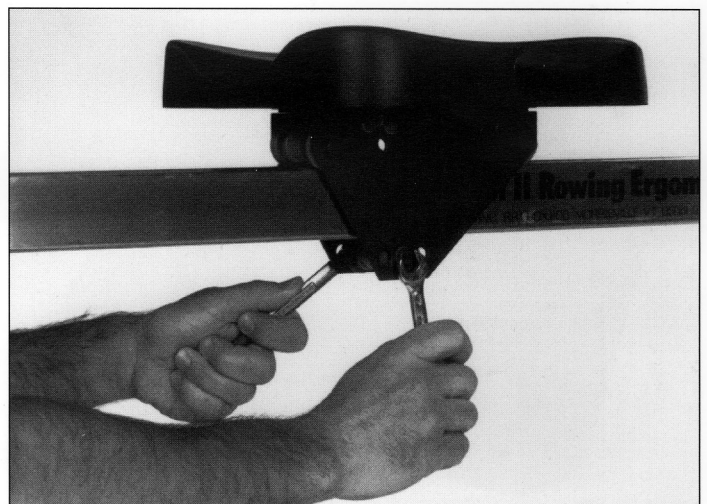

Do not overtighten.

11.