



PRODUCT MANUAL

 **concept 2**<sup>®</sup>

# RowERG



With STANDARD LEGS

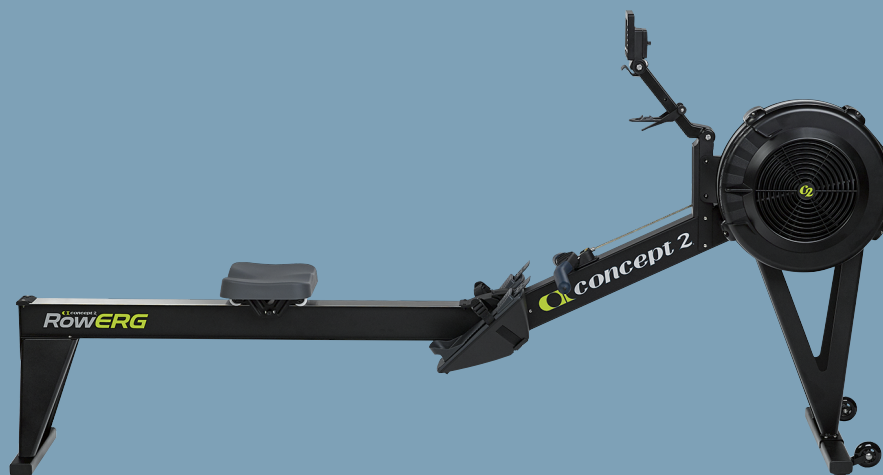

With TALL LEGS

## IMPORTANT USE AND SAFETY NOTES

- Use of this machine with a worn or weakened part, such as the chain, sprockets, chain/swivel connector, handle U-bolt or shock cord, may result in injury to the user. When in doubt about the condition of any part, Concept2 strongly advises that it be replaced immediately. Use only genuine Concept2 parts. Use of other parts may result in injury or poor performance of machine.
- The machine should be used on a stable, level surface.
- The machine should NOT be bolted or permanently fixed to the floor. Doing so may result in permanent damage to the frame.
- Keep children, pets, fingers and clothing away from seat rollers. Seat rollers can cause injury.
- Perform proper maintenance as described in the Maintenance section of this manual.
- Pull straight back with both hands. Do not row with one hand only. Abuse of the chain can result in injury.
- Never twist chain or pull from side to side.
- Place handle against the chain guide or in handle hooks before letting go. Do not let handle fly into chain guide.
- **ALWAYS PUT THE FRAMELOCK IN THE LOCKED POSITION WHEN THE FLYWHEEL AND MONORAIL SECTIONS ARE CONNECTED AND BEFORE MOVING THE ROVERG. FAILURE TO DO SO MAY RESULT IN INJURY IF THE UNIT IS LIFTED OR MOVED.**
- **To avoid possible injury, use caution while attaching the monorail section to the flywheel section and while operating the frame lock.**
- **DO NOT stand the RowErg up on end as it may tip over.**

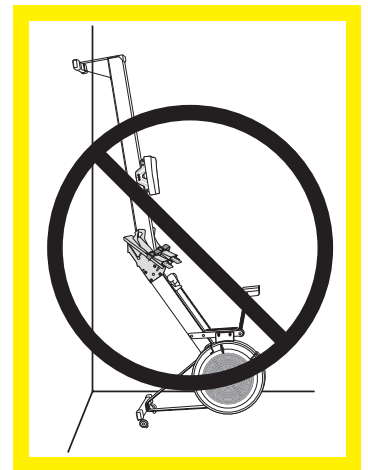
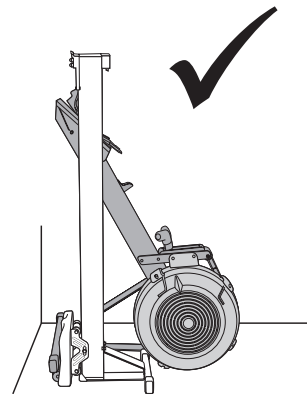
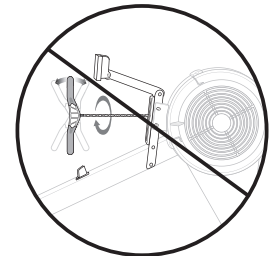
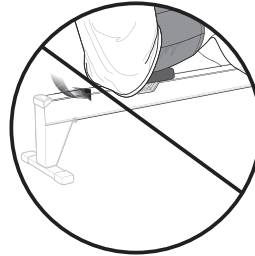
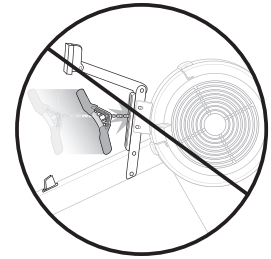
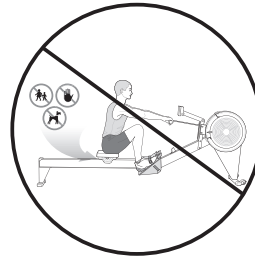

## RECOMMENDED MAINTENANCE SCHEDULE

### ON A REGULAR BASIS

Firmware is the internal software that runs your Performance Monitor. Your PM comes preinstalled with the latest firmware, however, new and improved versions are offered regularly. We offer free software called the Concept2 Utility that makes it easy to update your PM with the latest firmware version at any time. Visit [concept2.com/pm5firmware](http://concept2.com/pm5firmware) for more information.

### DAILY

Wipe stainless monorail top with a cloth or non-abrasive scouring pad after use with a household all-purpose cleaner. Do not use bleach products, mineral acids or coarse abrasives.

### EVERY 50 HOURS OF USE (Weekly for Institutional Users):

Lubricate the chain with a teaspoon of purified mineral oil, 3-IN-ONE® oil, or 20W motor oil. Apply oil to a paper towel, and rub the paper towel along entire length of chain. Wipe off the excess. Repeat if needed. Do not clean the chain with any kind of cleaner or solvent, e.g. WD-40®.



### WARNING!

The safety level of the machine can be maintained only if it is examined regularly for damage and wear. Replace defective components immediately to ensure safety and performance or keep machine out of use until repair.

### EVERY 250 HOURS OF USE (Monthly for institutional users):

1. Inspect chain for stiff links. If thorough lubrication does not help, the chain should be replaced.
2. Inspect chain-handle connection for wear. If the hole has become elongated, or the U-bolt is worn halfway through, replace the entire connection.
3. Tighten the shock cord if the handle does not return all the way to the fan enclosure.
4. Check screws for tightness, including those used for assembly.
5. Loosen or tighten the nuts on the Performance Monitor arm joints as necessary.
6. Check for dust inside flywheel with a flashlight. Vacuum if needed.

For complete maintenance information and instructions visit [concept2.com/service](http://concept2.com/service).

## BEFORE YOUR FIRST ROW

1. Consult your physician. Be sure that it is not dangerous for you to undertake a strenuous exercise program.
2. Carefully review the rowing technique information. Improper technique such as extreme layback or jumping off the seat can result in injury.

## PROPER ROWING TECHNIQUE

The rowing stroke can be divided into two parts: the drive and the recovery. The drive is in the work portion of the strokes; the recovery is the rest portion that prepares you for the next drive. The body movements of the recovery are essentially the reverse of the drive. Blend these movements into a smooth continuum to create the rowing stroke.

To view a video demonstrating proper rowing technique, visit [concept2.com/technique](http://concept2.com/technique).

[concept2.com/technique](http://concept2.com/technique)

### THE CATCH

- Arms are straight; head is neutral; shoulders are level and not hunched.
- Upper body is leaning forward from the hips with the shoulders in front of the hips.
- Shins are vertical, or as close to vertical as comfortable for you. Shins should not move beyond perpendicular.
- Heels may lift as needed.

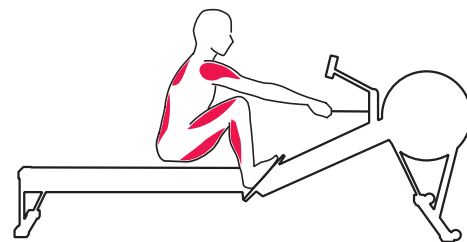

### THE DRIVE

- Start the drive by pressing with your legs, and then swing the back through the vertical position before finally adding the arm pull.
- Hands move in a straight line to and from the flywheel.
- Shoulders remain low and relaxed.

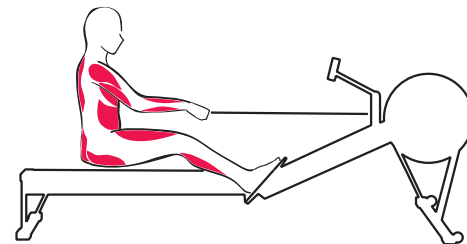

### THE FINISH

- Upper body is leaning back slightly, using good support from the core muscles.
- Legs are extended and handle is held lightly below your ribs.
- Shoulders should be low with wrists and grip relaxed. Wrists should be flat.

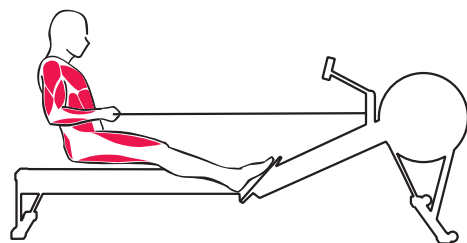

### THE RECOVERY

- Extend your arms until they straighten before leaning from the hips towards the flywheel.
- Once your hands have cleared your knees, allow your knees to bend and gradually slide the seat forward on the monorail.
- For your next stroke, return to the catch position with shoulders relaxed and shins vertical.

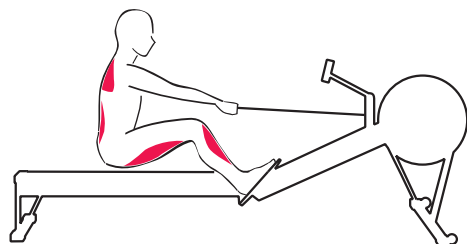

## GETTING STARTED

1. How to set up.
  - Set damper between 3 and 5 for the best aerobic workout.
  - Aim for a stroke rate of between 24 and 30 spm (strokes per minute).
  - Row no more than 5-10 minutes the first day to let your body adjust to the new exercise.
  - Focus on good technique. Visit [concept2.com/technique](http://concept2.com/technique).
2. Gradually increase time and intensity over the first two weeks.
  - Remember to warm up before starting to row harder.
  - Build intensity by pulling harder. The faster you get the flywheel spinning, the more resistance you will feel.
  - Do not row at full power until you are comfortable with the technique and have rowed for at least a week.
  - Like any physical activity, if you increase the volume and intensity too rapidly, fail to warm up properly, or use poor technique, you will increase the risk of injury.
3. Log your progress.
  - Keep yourself motivated by tracking your progress.
  - Sign up for our free Online Logbook, where you can record all your workouts and participate in the many challenges offered throughout the year. Visit [concept2.com/logbook](http://concept2.com/logbook).
  - Try our free app ErgData for additional workout data and easy uploading of results to your Online Logbook.

## DAMPER SETTINGS ON THE FLYWHEEL

The damper setting is like bicycle gearing. It affects the feel of the rowing but does not directly affect the resistance. With a little experimentation, you will find the damper setting that gives you the best workout and results. We recommend a damper setting of 3-5 for the best aerobic workout. This is the setting that feels most like a sleek, fast boat on the water. Higher settings feel more like a bigger, slower boat. Rowing with the damper setting too high can be detrimental to your training program because it may reduce your output and increase your risk of injury.

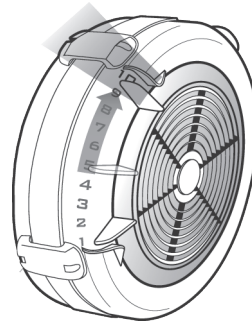

Up for slower

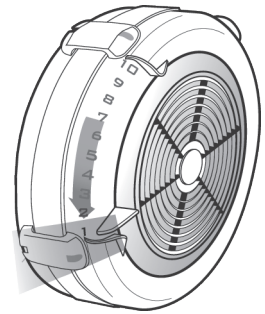

Down for faster

## WARRANTY

Concept2 RowErgs are backed by a limited 2 year and 5 year warranty. For complete warranty information in the US and Canada, visit [concept2.com/warranty](http://concept2.com/warranty).

For complete warranty information outside the US and Canada, contact the authorized Concept2 Preferred Reseller in your territory. A list of authorized Concept2 Preferred Resellers can be found at [concept2.com/international](http://concept2.com/international). If you do not find a Preferred Reseller in your territory email [c2global@concept2.com](mailto:c2global@concept2.com).